

Article number: 20474B20B15ELS

Description: E+G Two-way clamp mounting - GN 474-B20-B15-ELS

Measures

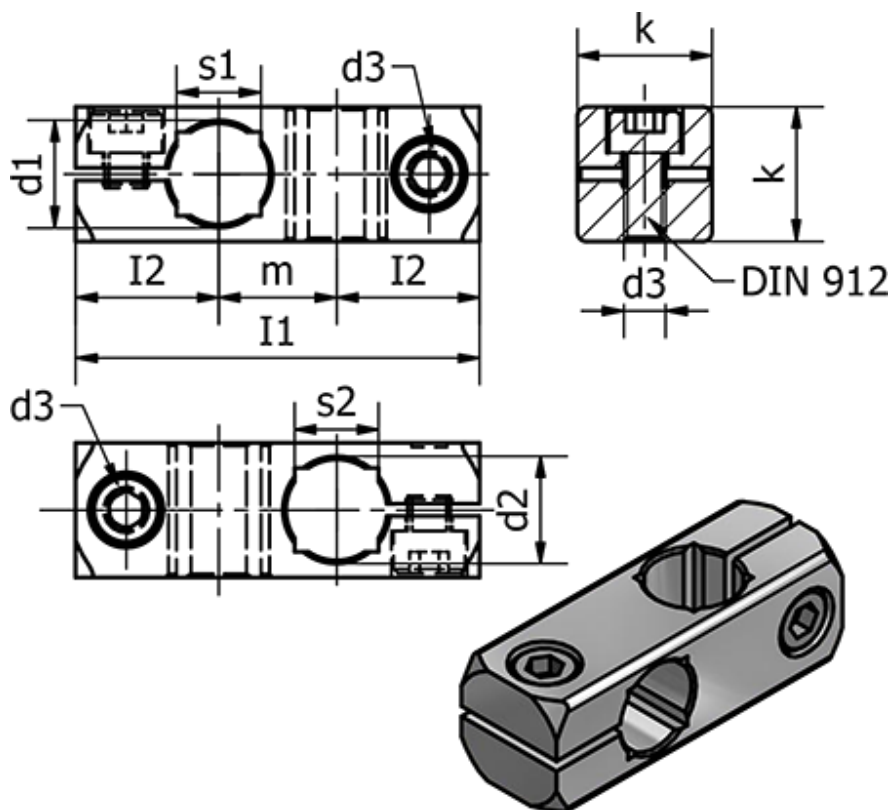

Clamping kit for d3 = GN 511-M6-20

d1 h11 = 20

d2 h11 = 15

d3 = 6

I1 = 65

I2 = 21.5

k = 25

m = 22

s1 = 16

s2 = 12

Weight (g) = 76